



**IBRA**  
SHOWERS

*BOX DOCCIA  
SHOWER ENCLOSURES  
PAROIS DE DOUCHE*

**BEST**  
> 6 mm

BEST

## BEST

### Caratteristiche / features / caractéristiques

- |  |   |   |
|--|---|---|
| <ul style="list-style-type: none"> <li>&gt; H 200 cm</li> <li>&gt; Chiusura a calamita inserita su profilo in alluminio</li> <li>&gt; Profili gocciolatoi in PVC trasparente antigoccia</li> <li>&gt; Profilo inferiore di contenimento acqua</li> <li>&gt; Porta battente sollevabile</li> <li>&gt; Braccetti di sostegno in alluminio accorciabili in opera</li> <li>&gt; Profili verticali dotati di tappi di chiusura trasparenti</li> <li>&gt; Possibilità di fuori misura</li> <li>&gt; Montaggio rapido</li> <li>&gt; Porta battente con apertura in/out</li> </ul> | <ul style="list-style-type: none"> <li>&gt; H 200 cm</li> <li>&gt; Magnetic closing system inserted in the aluminium seal</li> <li>&gt; Drip sealing strips in transparent PVC anti-mould</li> <li>&gt; Water containment profile</li> <li>&gt; Hinged door with lift system</li> <li>&gt; Aluminium stabilizing bar to be cut during installation</li> <li>&gt; Transparent upper covers for the adjustment profile</li> <li>&gt; Out of standard on request</li> <li>&gt; Easy to assemble</li> <li>&gt; Hinged door with in-out opening</li> </ul> | <ul style="list-style-type: none"> <li>&gt; H 200 cm</li> <li>&gt; Fermeture magnétique insérée dans le profil en aluminium</li> <li>&gt; Profils en PVC contre l'éclaboussement</li> <li>&gt; Profils inférieur pour le confinement de l'eau</li> <li>&gt; Porte battente relevable</li> <li>&gt; Soutiens en aluminium à couper en cours de réalisation</li> <li>&gt; Profils verticaux avec bouchons de fermeture transparents</li> <li>&gt; Hors standard sur demande</li> <li>&gt; Assemblage rapide</li> <li>&gt; Porte battente avec ouverture in/out</li> </ul> |
|--|---|---|

### Vetri / glasses / verre



- |                                  |                                    |                               |                             |                             |                               |   |
|----------------------------------|------------------------------------|-------------------------------|-----------------------------|-----------------------------|-------------------------------|---|
| <p><b>00</b><br/>Trasparente</p> | <p><b>GE</b><br/>Grigio Europa</p> | <p><b>SA</b><br/>Satinato</p> | <p><b>BZ</b><br/>Bronzo</p> | <p><b>X1</b><br/>Nuvola</p> | <p><b>TL</b><br/>Timeless</p> | <p><b>X2-X3-X4-X5</b><br/>Serigrafie<br/>(v. pag. 371)<br/>Serigraphies<br/>(see page 371)<br/>Sérigraphies<br/>(voir page 371)</p> |
|                                  |                                    |                               |                             |                             |                               | <p><b>EC</b><br/>Extrachiaro</p>  |

### Profili / profiles / profils

#### SPECIAL:



- |                           |                          |   |
|---------------------------|--------------------------|---|
| <p><b>B</b><br/>Brill</p> | <p><b>N</b><br/>Nero</p> | <p><b>9</b><br/>Laccato<br/>Lacquered<br/>Laqué</p> |
|---------------------------|--------------------------|---|

## BEST - MANIGLIE



### FIRMA maniglia di serie as standard de série

- > Fissata sul vetro
- > Fixed to the glass
- > Fixée au verre



### TI alternativa (specificare nell'ordine) optional (to specify in the order) alternative (indiquer dans la commande)

- > Fissata sul vetro
- > Fixed to the glass
- > Fixée au verre



### WING alternativa (specificare nell'ordine) optional (to specify in the order) alternative (indiquer dans la commande)

- > Fissata sul vetro
- > Fixed to the glass
- > Fixée au verre

# BEST - TECHNICS

## ICON - NICCHIA - PORTA BATTENTE

NICHE - HINGED DOOR  
NICHE - PORTE BATTANTE

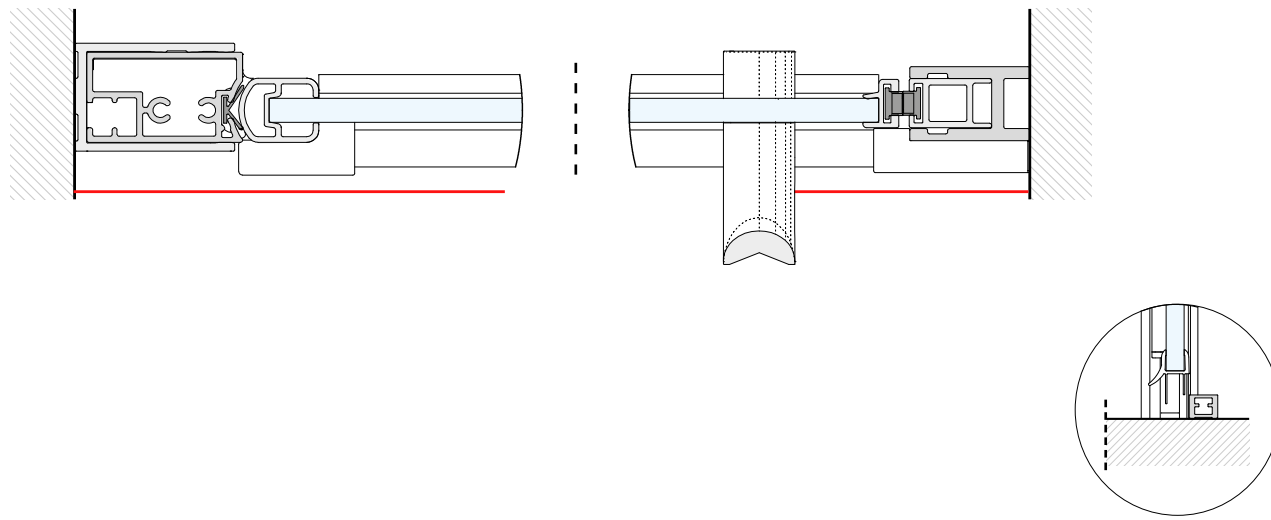

## ICON - NICCHIA - PORTA BATTENTE CON FISSO LATERALE

NICHE - HINGED DOOR WITH IN-LINE FIXED PANEL  
NICHE - PORTE BATTANTE AVEC PAROI FIXE ALIGNÉE

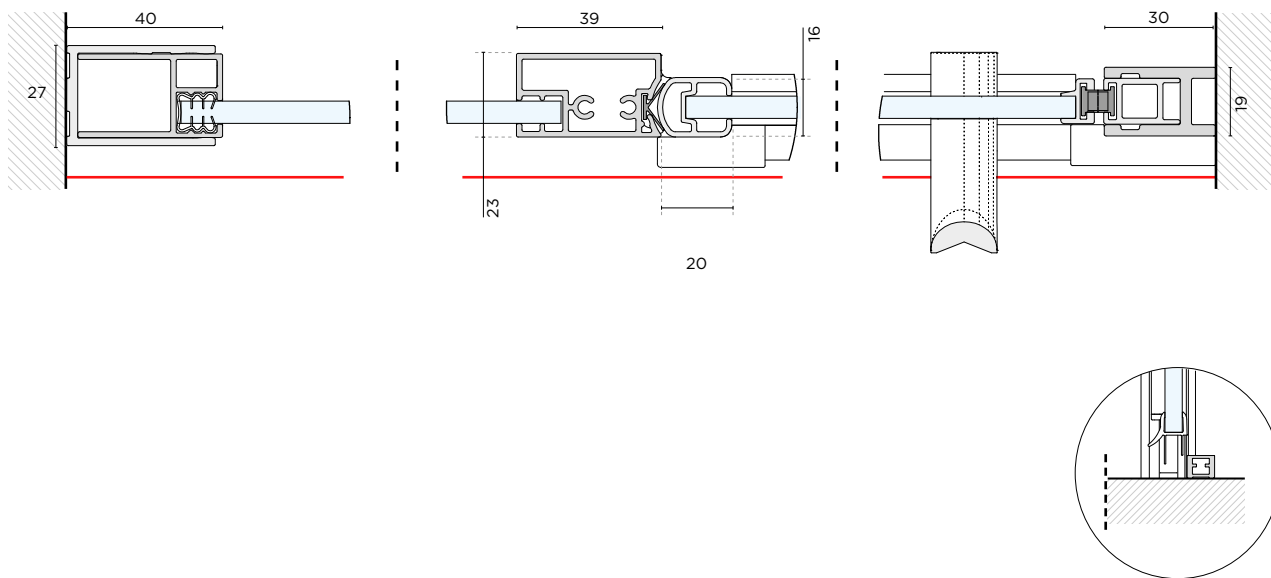

# BEST

## Configurazioni / configurations / configurations

Di serie:  
Standard:  
De série:



**NICCHIA**  
**> 1 porta**

1 door

1 porte



**NICCHIA**  
**> 1 porta a muro**  
**+ fisso in linea**

1 door wall-mounted  
with in-line fixed  
panel

Porte battante montée  
sur le mur + paroi fixe  
alignées

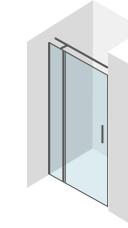

**NICCHIA**  
**> 1 porta**  
**+ fisso in linea**

1 door with  
in-line fixed panel

Porte pivotante  
+ paroi fixe alignées



**NICCHIA**  
**> 2 porte**

2 doors

2 portes



**NICCHIA**  
**> 2 porta**  
**+ fissi in linea**

2 hinged doors  
+ 2 in-line fixed  
panels

2 portes battantes  
+ 2 parois fixes  
alignées

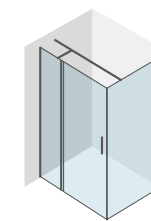

**ANGOLO**  
**> 1 porta**  
**+ fisso in linea**

1 door with  
in-line fixed panel

1 porte  
+ paroi fixe  
alignées



**ANGOLO**  
**> 1 porta**

1 door

1 porte

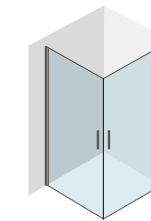

**ANGOLO**  
**> 2 porte**

2 doors

2 portes

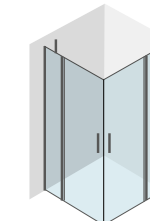

**ANGOLO**  
**> 2 porte**  
**+ fissi in linea**

2 hinged doors  
+ 2 in-line fixed  
panels

2 portes battantes  
+ 2 parois fixes  
alignées

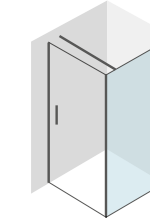

**LATO AGGIUNTIVO**  
**> Angolo 1 porta**  
**battente + fisso**  
**laterale**

Hinged door + fixed  
lateral panel

Porte battante  
+ paroi fixe latéral

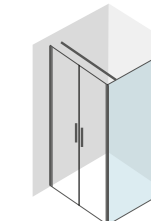

**LATO AGGIUNTIVO**  
**> Angolo 2 porte**  
**battenti con fisso**  
**laterale**

2 hinged doors + fixed  
lateral panels

2 portes battantes +  
paroi fixe latéral

**A richiesta**  
**(contattare ufficio**  
**tecnico):**  
On request  
(to be verified  
with technical  
department):  
Sur demande  
(vérifier avec  
le département  
technique):



**SOPRA MURETTO**  
**> Battente + fisso**  
**laterale**

Hinged doors + fixed  
lateral panel over a wall

Portes battantes + côté  
fixe latéral sur le mur

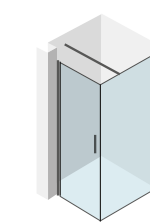

**LATO COLONNA**  
**> Battente lato colonna**  
**+ fisso laterale**

Hinged door + fixed  
lateral panel

Porte battante + côté  
fixe latéral

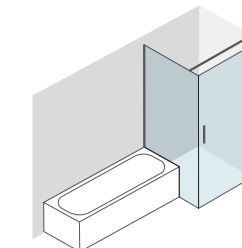

**SAGOMATO**  
**> Battente + fisso**  
**laterale sagomato**

Hinged door + shaped  
fixed lateral panel

Porte battante + paroi  
fixe latérale façonnée

---

## BEST: **BATTENTE** **HINGED DOOR** **BATTANTE**

### LEGENDA

KEY / LÉGENDE

- F** fisso / fixed panel / côté fixe  
**L** lato / fixed lateral panel / côté fixe latéral  
**A** apertura / opening / entrée  
**P** porta / door / porte

---

### Dettagli / details / détails



**Maniglia di serie:**  
A ponte, con un comodo pomolo per l'apertura dall'interno.

Standard handle:  
With a bridge shape and a knob to open from the inside.

Poignée de série:  
A pont, avec un bouton pratique pour ouvrir la porte de l'intérieur.



**Cerniera integrata:**  
La cerniera è integrata nel profilo montante, per garantire una grande apertura utile.

Integrated hinge:  
The hinge is integrated in the vertical profile to maximize the opening.

Charnière intégrée:  
La charnière est intégrée dans le profile vertical pour permettre un passage maximal.



**Sollevarmento porta:**  
La porta si solleva in apertura ed è dotata di un fermo a 90° per tenerla in posizione.

Lifting of the door:  
The door is lifted during the opening phase and it has a mechanical stop at 90° to keep it in position.

Relèvement de la porte:  
La porte est reléevée pendant l'ouverture et elle est équipée d'un arrêt mécanique à 90° pour la garder en position.



# 01.

**Porta battente  
con fisso in linea  
+ fisso laterale**  
nero + vetro Grigio Europa

*Hinged door  
with in-line fixed panel  
+ fixed panel lateral  
in nero + Grigio Europa glass*

**Porte battante  
avec paroi fixe alignée  
+ côté fixe latéral**  
nero + verre Grigio Europa

---

Piatto doccia:  
**Parallel Bianco**  
L 120 x P 80 cm

*Shower tray:*  
**Parallel Bianco**  
W 120 x D 80 cm

*Receveur:*  
**Parallel Bianco**  
L 120 x P 80 cm





**Cerniera a tutta altezza:**  
eleganza e attenzione al dettaglio

**Hinge integrated in the vertical profile:**  
elegance and attention to the detail

**Charnière intégrée dans le profilé vertical:**  
élégance et attention au détail





## 02.

**Porta battente  
in nicchia**  
nero + vetro trasparente

*Hinged door  
in niche*  
in nero + trasparente glass

**Porte battante  
en niche**  
nero + verre transparente

---

Piatto doccia:  
**Parallel Bianco**  
L 80 x P 80 cm

Shower tray:  
**Linear Bianco**  
W 80 x D 80 cm

Receveur:  
**Linear Bianco**  
L 80 x P 80 cm

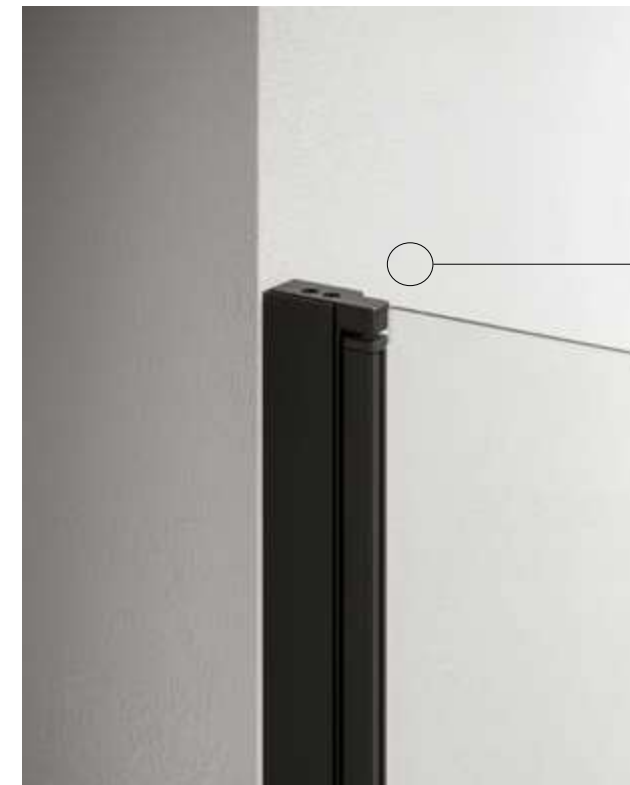

**Camma di sollevamento:**  
per un apertura fluida anche con piatti a filo pavimento

**Lifting mechanism:**  
for a fluid opening even with shower tray flush to the floor

**Mécanisme de relèvement:**  
pour une ouverture fluide, même en présence d'un receveur au ras du sol



**Cerniera a tutta altezza**  
consente di aprire la porta verso l'interno e l'esterno

**Hinge integrated in the vertical profile:**  
in/out opening

**Charnière intégrée dans le profile vertical:**  
ouverture in/out





## 03.

**Doppia porta battente  
ad angolo**  
brill + vetro con  
serigrafia Garza

*2 hinged doors  
corner  
in brill + Garza glass*

*2 portes battantes  
en coin  
brill + Garza glass*

---

Piatto doccia:  
**Elle Bianco**  
L 90 x P 90 cm

*Shower tray:  
Elle Bianco  
W 90 x D 90 cm*

*Receveur:  
Elle Bianco  
L 90 x P 90 cm*



**Apertura a 180°**  
per una totale  
accessibilità

**180° opening:**  
for a full accessibility

**Ouverture à 180°:**  
pour un passage optimal



# BEST BATTENTE

Nicchia  
Niche  
Niche

Porta battente  
Hinged door  
Porte battante

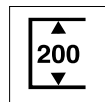

**Altezza 200 cm**  
Height 200 cm  
Hauteur 200 cm

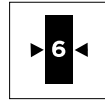

**Vetro sp. 6 mm**  
Glass th. 6 mm  
Verre ép. 6 mm



**Fuori misura:**  
**altezza max 210 cm / larghezza max 100 cm**  
Out of standard:  
height max. 210 cm / width max. 100 cm  
Sur demande:  
hauteur max. 210 cm / largeur max. 100 cm

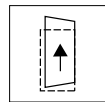

**Cerniera con sollevamento in apertura**  
Hinge with lifting mechanism while opening  
Charnière avec mécanisme de levage pendant l'ouverture

**ATTENZIONE!**

La larghezza della porta (P) è data dall'apertura (A) + 3 cm.  
Total width of the door (P) is given by width of opening (A) + 3 cm.  
La largeur totale de la porte (P) est donnée par l'addition de l'ouverture (A) + 3 cm

**Configurazioni:**  
Configurations:  
Configurations:



**Fuori Misura:**  
Out of standard:  
Sur mesure:



**(richiedere fattibilità)**  
(ask for feasibility)  
(vérifier la faisabilité avec le service technique)

**Trattamento anticalcare:**  
Glass treatment:  
Traitement verre:



**Lato**  
Side  
Verre

**Vetro Extralight / Timeless:**  
Extralight/Timeless glass:  
Verre Extralight/Timeless:



**Vetro con serigrafie:**  
Serigraphies (see page 371):  
Sérigraphies (voir page 371):



**maggiorazione dal TRASPARENTE**  
increase on the TRASPARENTE price  
à partir du prix du TRASPARENTE

**Vetro Nuvola:**  
Nuvola glass (see page 371):  
Verre Nuvola (voir page 371):



**Profili speciali:**  
Special profiles:  
Profils special:

> LACCATO  
> LACQUERED  
> LAQUE



**Porta**  
Door  
Porte

**Fisso**  
Fixed panel  
Côté fixe

# BEST BATTENTE

Nicchia  
Niche  
Niche

Porta battente  
Hinged door  
Porte battante

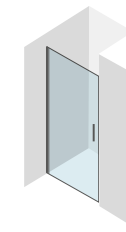

**ATTENZIONE**  
Specificare il verso al momento dell'ordine.

**ATTENTION**  
Indicate the side in the order.

**ATTENTION**  
Indiquer le vers dans la commande.

**P - PORTA BATTENTE / HINGED DOOR / PORTE BATTANTE**

ART. ITEM ART.	ESTENSIBILITÀ EXTENSIBILITY EXTENSIBILITÉ	PIATTO TRAY RECEVEUR	APERTURA OPENING ENTRÉE	FISSO FIXED FIXE	PROFILO PROFILE PROFIL	VETRO/GLASS/VERRE TRASPARENTE	VETRO/GLASS/VERRE GRIGIO EUROPA SATIN - BRONZO
D6LN100	66-69	70	57		BRILL		
					NERO		
D6LN105	71-74	75	62		BRILL		
					NERO		
D6LN110	76-79	80	67		BRILL		
					NERO		
D6LN115	81-84	85	72		BRILL		
					NERO		
D6LN120	86-89	90	77		BRILL		
					NERO		
D6LN125	91-94	95	82		BRILL		
					NERO		
D6LN130	96-99	100	87		BRILL		
					NERO		

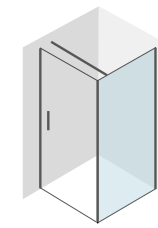

**ATTENZIONE**  
Specificare il verso al momento dell'ordine.

**ATTENTION**  
Indicate the side in the order.

**ATTENTION**  
Indiquer le vers dans la commande.

**L - FISSO AGGIUNTIVO / FIXED PANEL / CÔTÉ FIXE**

ART. ITEM ART.	ESTENSIBILITÀ EXTENSIBILITY EXTENSIBILITÉ	PIATTO TRAY RECEVEUR	APERTURA OPENING ENTRÉE	FISSO FIXED FIXE	PROFILO PROFILE PROFIL	VETRO/GLASS/VERRE TRASPARENTE	VETRO/GLASS/VERRE GRIGIO EUROPA SATIN - BRONZO
D6LF100	67,5-69,5	70			BRILL		
					NERO		
D6LF105	72,5-74,5	75			BRILL		
					NERO		
D6LF110	77,5-79,5	80			BRILL		
					NERO		
D6LF115	82,5-84,5	85			BRILL		
					NERO		
D6LF120	87,5-89,5	90			BRILL		
					NERO		
D6LF125	92,5-94,5	95			BRILL		
					NERO		
D6LF130	97,5-99,5	100			BRILL		
					NERO		

# BEST BATTENTE

Nicchia  
Niche  
Niche

Porta battente a muro + fisso in linea  
Hinged door with in-line fixed panel  
Porte battante avec paroi fixe alignée

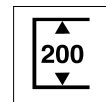

**Altezza 200 cm**  
Height 200 cm  
Hauteur 200 cm

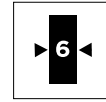

**Vetro sp. 6 mm**  
Glass th. 6 mm  
Verre ép. 6 mm



**Fuori misura:**  
**altezza max 210 cm / larghezza max 160 cm**  
Out of standard:  
height max. 210 cm / width max. 160 cm  
Sur demande:  
hauteur max. 210 cm / largeur max. 160 cm



**Braccetto (A) accorciabile in opera compreso nel prezzo**  
Stabilizing bar (A) to be cutted during installation included  
Barre de soutien (A) à couper en cours de réalisation comprise dans le prix.

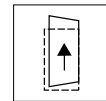

**Cerniera con sollevamento in apertura**  
Hinge with lifting mechanism while opening  
Charnière avec mécanisme de levage pendant l'ouverture

**Configurazioni:**  
Configurations:  
Configurations:

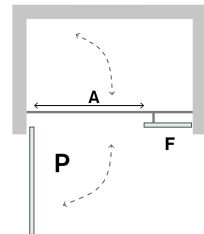

**VERSIONE SX**  
Left  
Gauche

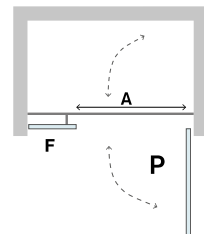

**VERSIONE DX**  
Right  
Droite

**ATTENZIONE!**

La larghezza della porta (P) è data dall'apertura (A) + 3 cm.  
Total width of the door (P) is given by width of opening (A) + 3 cm.  
La largeur totale de la porte (P) est donnée par l'addition de l'ouverture (A) + 3 cm

**Fuori Misura:**  
Out of standard:  
Sur mesure:



**(richiedere fattibilità)**  
(ask for feasibility)  
(vérifier la faisabilité avec le service technique)

**Trattamento anticalcare:**  
Glass treatment:  
Traitement verre:



**Lato**  
Side  
Verre

**Vetro Extralight / Timeless:**  
Extralight/Timeless glass:  
Verre Extralight/Timeless:



**Vetro con serigrafie:**  
Serigraphies (see page 371):  
Sérigraphies (voir page 371):



**maggiorazione dal TRASPARENTE**  
increase on the TRASPARENTE price  
à partir du prix du TRASPARENTE

**Vetro Nuvola:**  
Nuvola glass (see page 371):  
Verre Nuvola (voir page 371):



**Profili speciali:**  
Special profiles:  
Profils special:

> LACCATO  
> LACQUERED  
> LAQUE



**Lato**  
Side  
Verre

# BEST BATTENTE

Nicchia  
Niche  
Niche

Porta battente a muro + fisso in linea  
Hinged door with in-line fixed panel  
Porte battante avec paroi fixe alignée



**ATTENZIONE**  
Specificare il verso al momento dell'ordine.

**ATTENTION**  
Indicate the side in the order.

**ATTENTION**  
Indiquer le vers dans la commande.

## P - PORTA BATTENTE / HINGED DOOR / PORTE BATTANTE

ART. ITEM ART.	ESTENSIBILITÀ EXTENSIBILITÉ	PIATTO TRAY RECEVEUR	APERTURA OPENING ENTRÉE	FISSO FIXED FIXE	PROFILO PROFILE PROFIL	VETRO/GLASS/VERRE TRASPARENTE	VETRO/GLASS/VERRE GRIGIO EUROPA SATIN - BRONZO
D6LN400	85-89	90	57	22	BRILL		
					NERO		
D6LN405	90-94	95	57	27	BRILL		
					NERO		
D6LN410	95-99	100	57	32	BRILL		
					NERO		
D6LN415	100-104	105	62	32	BRILL		
					NERO		
D6LN420	105-109	110	62	37	BRILL		
					NERO		
D6LN425	110-114	115	62	42	BRILL		
					NERO		
D6LN430	115-119	120	62	47	BRILL		
					NERO		
D6LN435	120-124	125	67	47	BRILL		
					NERO		
D6LN440	125-129	130	67	52	BRILL		
					NERO		
D6LN445	130-134	135	67	57	BRILL		
					NERO		
D6LN450	135-139	140	67	62	BRILL		
					NERO		



# BEST BATTENTE

Nicchia  
Niche  
Niche

Porta battente + fisso in linea  
Hinged door with in-line fixed panel  
Porte battante avec paroi fixe alignée

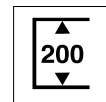

**Altezza 200 cm**  
Height 200 cm  
Hauteur 200 cm

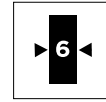

**Vetro sp. 6 mm**  
Glass th. 6 mm  
Verre ép. 6 mm



**Fuori misura:**  
**altezza max 210 cm / larghezza max 160 cm**  
Out of standard:  
height max. 210 cm / width max. 160 cm  
Sur demande:  
hauteur max. 210 cm / largeur max. 160 cm



**Braccetto (A) accorciabile in opera compreso nel prezzo**  
Stabilizing bar (A) to be cut during installation included  
Barre de soutien (A) à couper en cours de réalisation comprise dans le prix.

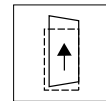

**Cerniera con sollevamento in apertura**  
Hinge with lifting mechanism while opening  
Charnière avec mécanisme de levage pendant l'ouverture



**Configurazioni:**  
Configurations:  
Configurations:

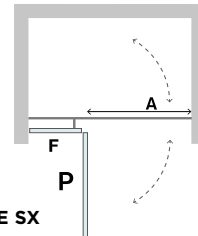

**VERSIONE SX**  
Left  
Gauche

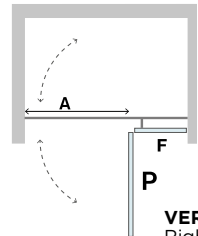

**VERSIONE DX**  
Right  
Droite

**ATTENZIONE!**

La larghezza della porta (P) è data dall'apertura (A) + 3 cm.  
Total width of the door (P) is given by width of opening (A) + 3 cm.  
La largeur totale de la porte (P) est donnée par l'addition de l'ouverture (A) + 3 cm

**Fuori Misura:**  
Out of standard:  
Sur mesure:



**(richiedere fattibilità)**  
(ask for feasibility)  
(vérifier la faisabilité avec le service technique)

**Trattamento anticalcare:**  
Glass treatment:  
Traitement verre:



**Lato**  
Side  
Verre

**Vetro Extralight / Timeless:**  
Extralight/Timeless glass:  
Verre Extralight/Timeless:



**Vetro con serigrafie:**  
Serigraphies (see page 371):  
Sérigraphies (voir page 371):



**maggiorazione dal TRASPARENTE**  
increase on the TRASPARENTE price  
à partir du prix du TRASPARENTE

**Vetro Nuvola:**  
Nuvola glass (see page 371):  
Verre Nuvola (voir page 371):



**Profili speciali:**  
Special profiles:  
Profils special:

> LACCATO  
> LACQUERED  
> LAQUE



**Lato**  
Side  
Verre

# BEST BATTENTE

Nicchia  
Niche  
Niche

Porta battente + fisso in linea  
Hinged door with in-line fixed panel  
Porte battante avec paroi fixe alignée

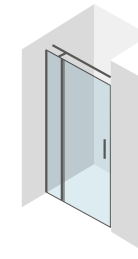

**ATTENZIONE**  
Specificare il verso al momento dell'ordine.

**ATTENTION**  
Indicate the side in the order.

**ATTENTION**  
Indiquer le vers dans la commande.

## P - PORTA BATTENTE / HINGED DOOR / PORTE BATTANTE

ART. ITEM ART.	ESTENSIBILITÀ EXTENSIBILITY EXTENSIBILITÉ	PIATTO TRAY RECEVEUR	APERTURA OPENING ENTRÉE	FISSO FIXED FIXE	PROFILO PROFILE PROFIL	VETRO/GLASS/VERRE TRASPARENTE	VETRO/GLASS/VERRE GRIGIO EUROPA SATIN - BRONZO
D6LN200	86-89	90	57	25	BRILL		
					NERO		
D6LN205	91-94	95	57	30	BRILL		
					NERO		
D6LN210	96-99	100	57	35	BRILL		
					NERO		
D6LN215	101-104	105	62	35	BRILL		
					NERO		
D6LN220	106-109	110	62	40	BRILL		
					NERO		
D6LN225	111-114	115	62	45	BRILL		
					NERO		
D6LN230	116-119	120	62	50	BRILL		
					NERO		
D6LN235	121-124	125	67	50	BRILL		
					NERO		
D6LN240	126-129	130	67	55	BRILL		
					NERO		
D6LN245	131-134	135	67	60	BRILL		
					NERO		
D6LN250	136-139	140	67	65	BRILL		
					NERO		
D6LN255	141-144	145	67	70	BRILL		
					NERO		
D6LN260	146-149	150	67	75	BRILL		
					NERO		



# BEST BATTENTE

Nicchia  
Niche  
Niche

2 porte battenti  
2 hinged doors  
2 portes battantes

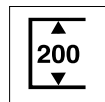

**Altezza 200 cm**  
Height 200 cm  
Hauteur 200 cm

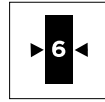

**Vetro sp. 6 mm**  
Glass th. 6 mm  
Verre ép. 6 mm



**Fuori misura:**  
**altezza max 210 cm / larghezza max 160 cm**  
Out of standard:  
height max. 210 cm / width max. 160 cm  
Sur demande:  
hauteur max. 210 cm / largeur max. 160 cm

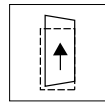

**Cerniera con sollevamento in apertura**  
Hinge with lifting mechanism while opening  
Charnière avec mécanisme de levage pendant l'ouverture

**Configurazioni:**  
Configurations:  
Configurations:

**VERSIONE SX /DX**  
Left / Right  
Gauche / Droite

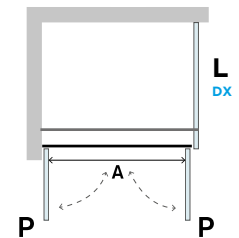
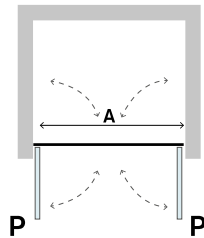

**VERSIONE SX /DX**  
Left / Right  
Gauche / Droite

**Fuori Misura:**  
Out of standard:  
Sur mesure:



**(richiedere fattibilità)**  
(ask for feasibility)  
(vérifier la faisabilité avec le service technique)

**Trattamento anticalcare:**  
Glass treatment:  
Traitement verre:



**Lato**  
Side  
Verre

**Vetro Extralight / Timeless:**  
Extralight/Timeless glass:  
Verre Extralight/Timeless:



**Vetro con serigrafie:**  
Serigraphies (see page 371):  
Sérigraphies (voir page 371):



**maggiorazione dal TRASPARENTE**  
increase on the TRASPARENTE price  
à partir du prix du TRASPARENTE

**Vetro Nuvola:**  
Nuvola glass (see page 371):  
Verre Nuvola (voir page 371):



**Profili speciali:**  
Special profiles:  
Profils special:

> LACCATO  
> LACQUERED  
> LAQUE



**Lato**  
Side  
Verre

**Fisso**  
Fixed panel  
Côté fixe

# BEST BATTENTE

Nicchia  
Niche  
Niche

2 porte battenti  
2 hinged doors  
2 portes battantes

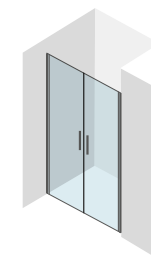

## P - PORTA BATTENTE / HINGED DOOR / PORTE BATTANTE

ART. ITEM ART.	ESTENSIBILITÀ EXTENSIBILITY EXTENSIBILITÉ	PIATTO TRAY RECEVEUR	APERTURA OPENING ENTRÉE	FISSO FIXED FIXE	PROFILO PROFILE PROFIL	VETRO/GLASS/VERRE TRASPARENTE	VETRO/GLASS/VERRE GRIGIO EUROPA SATIN - BRONZO
D6LN300	66-70	70	53		BRILL NERO		
D6LN305	71-75	75	58		BRILL NERO		
D6LN310	76-80	80	63		BRILL NERO		
D6LN315	81-85	85	68		BRILL NERO		
D6LN320	86-90	90	73		BRILL NERO		
D6LN325	91-95	95	78		BRILL NERO		
D6LN330	96-100	100	83		BRILL NERO		
D6LN335	101-105	105	88		BRILL NERO		
D6LN340	106-110	110	93		BRILL NERO		
D6LN345	111-115	115	98		BRILL NERO		
D6LN350	116-120	120	103		BRILL NERO		
D6LN355	121-125	125	108		BRILL NERO		
D6LN360	126-130	130	113		BRILL NERO		
D6LN365	131-135	135	118		BRILL NERO		
D6LN370	136-140	140	123		BRILL NERO		

## L - FISSO AGGIUNTIVO / FIXED LATERAL PANEL / CÔTÉ FIXE LATÈRAL

ART. ITEM ART.	ESTENSIBILITÀ EXTENSIBILITY EXTENSIBILITÉ	PIATTO TRAY RECEVEUR	APERTURA OPENING ENTRÉE	FISSO FIXED FIXE	PROFILO PROFILE PROFIL	VETRO/GLASS/VERRE TRASPARENTE	VETRO/GLASS/VERRE GRIGIO EUROPA SATIN - BRONZO
D6LF100	67,5-69,5	70			BRILL NERO		
D6LF105	72,5-74,5	75			BRILL NERO		
D6LF110	77,5-79,5	80			BRILL NERO		
D6LF115	82,5-84,5	85			BRILL NERO		
D6LF120	87,5-89,5	90			BRILL NERO		
D6LF125	92,5-94,5	95			BRILL NERO		
D6LF130	97,5-99,5	100			BRILL NERO		



**ATTENZIONE**  
Specificare il verso al momento dell'ordine.

**ATTENTION**  
Indicate the side in the order.

**ATTENTION**  
Indiquer le vers dans la commande.

# BEST BATTENTE

Nicchia  
Niche  
Niche

**2 porte battenti + fissi in linea**  
2 hinged doors with 2 in-line fixed panels  
2 portes battantes avec 2 parois fixes alignées

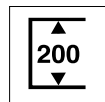

**Altezza 200 cm**  
Height 200 cm  
Hauteur 200 cm

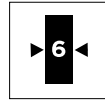

**Vetro sp. 6 mm**  
Glass th. 6 mm  
Verre ép. 6 mm



**Fuori misura:**  
**altezza max 210 cm / larghezza max 200 cm**  
Out of standard:  
height max. 210 cm / width max. 200 cm  
Sur demande:  
hauteur max. 210 cm / largeur max. 200 cm



**Braccetto (A) accorciabile in opera compreso nel prezzo**  
Stabilizing bar (A) to be cutted during installation included  
Barre de soutien (A) à couper en cours de réalisation comprise dans le prix.

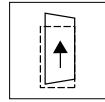

**Cerniera con sollevamento in apertura**  
Hinge with lifting mechanism while opening  
Charnière avec mécanisme de levage pendant l'ouverture

**Configurazioni:**  
Configurations:  
Configurations:

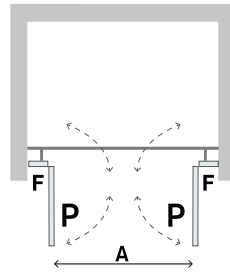

**VERSIONE SX / DX**  
Left / Right  
Gauche / Droite

**Fuori Misura:**  
Out of standard:  
Sur mesure:



**(richiedere fattibilità)**  
(ask for feasibility)  
(vérifier la faisabilité avec le service technique)

**Trattamento anticalcare:**  
Glass treatment:  
Traitement verre:



**Lato**  
Side  
Verre

**Vetro Extralight / Timeless:**  
Extralight/Timeless glass:  
Verre Extralight/Timeless:



**Vetro con serigrafie:**  
Serigraphies (see page 371):  
Sérigraphies (voir page 371):



**maggiorazione dal TRASPARENTE**  
increase on the TRASPARENTE price  
à partir du prix du TRASPARENTE

**Vetro Nuvola:**  
Nuvola glass (see page 371):  
Verre Nuvola (voir page 371):



**Profili speciali:**  
Special profiles:  
Profils special:

> LACCATO  
> LACQUERED  
> LAQUE



**Lato**  
Side  
Verre

# BEST BATTENTE

Nicchia  
Niche  
Niche

**2 porte battenti + fissi in linea**  
2 hinged doors with 2 in-line fixed panels  
2 portes battantes avec 2 parois fixes alignées

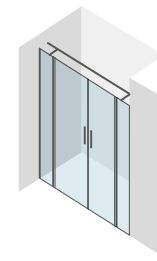

## P1 / P2 - PORTA BATTENTE / HINGED DOOR / PORTE BATTANTE

ART. ITEM ART.	ESTENSIBILITÀ EXTENSIBILITY EXTENSIBILITÉ	PIATTO TRAY RECEVEUR	APERTURA OPENING ENTRÉE	FISSO FIXED FIXE	PROFILO PROFILE PROFIL	VETRO/GLASS/VERRE TRASPARENTE	VETRO/GLASS/VERRE GRIGIO EUROPA SATIN - BRONZO
D6LN500	120,5-124,5	125	63	28	BRILL		
					NERO		
D6LN505	125,5-129,5	130	63	31	BRILL		
					NERO		
D6LN510	130,5-134,5	135	73	28	BRILL		
					NERO		
D6LN515	135,5-139,5	140	73	31	BRILL		
					NERO		
D6LN520	140,5-144,5	145	83	28	BRILL		
					NERO		
D6LN525	145,5-149,5	150	83	31	BRILL		
					NERO		
D6LN530	150,5-154,5	155	93	28	BRILL		
					NERO		
D6LN535	155,5-159,5	160	93	31	BRILL		
					NERO		
D6LN540	160,5-164,5	165	103	28	BRILL		
					NERO		
D6LN545	165,5-169,5	170	103	31	BRILL		
					NERO		
D6LN550	170,5-174,5	175	113	28	BRILL		
					NERO		
D6LN555	175,5-179,5	180	113	31	BRILL		
					NERO		

# BEST BATTENTE

Angolo  
Corner  
Coin

Porta battente + fisso laterale  
Hinged door + fixed lateral panel  
Porte battante + côté fixe latéral

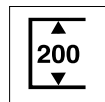

**Altezza 200 cm**  
Height 200 cm  
Hauteur 200 cm

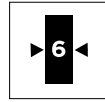

**Vetro sp. 6 mm**  
Glass th. 6 mm  
Verre ép. 6 mm



**Fuori misura:**  
**altezza max 210 cm / larghezza max 100 cm / profondità max 120 cm**  
Out of standard:  
height max. 210 cm / width max. 100 cm /  
depth max. 120 cm  
Sur demande:  
hauteur max. 210 cm / largeur max. 100 cm /  
profondeur max. 120 cm



**Braccetto (A) accorciabile in opera compreso nel prezzo**  
Stabilizing bar (A) to be cutted during installation included  
Barre de soutien (A) à couper en cours de réalisation comprise dans le prix.

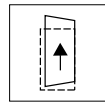

**Cerniera con sollevamento in apertura**  
Hinge with lifting mechanism while opening  
Charnière avec mécanisme de levage pendant l'ouverture



**Configurazioni:**  
Configurations:  
Configurations:

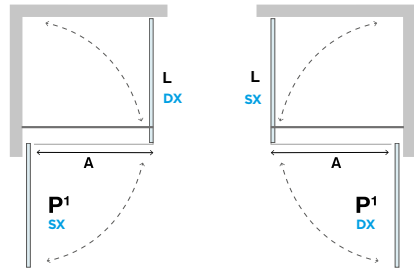

**VERSIONE SX**  
Left  
Gauche

**VERSIONE DX**  
Right  
Droite

**ATTENZIONE!**

La larghezza della porta (P) è data dall'apertura (A) + 3 cm.  
Total width of the door (P) is given by width of opening (A) + 3 cm.  
La largeur totale de la porte (P) est donnée par l'addition de l'ouverture (A) + 3 cm

**Fuori Misura:**  
Out of standard:  
Sur mesure:



**(richiedere fattibilità)**  
(ask for feasibility)  
(vérifier la faisabilité avec le service technique)

**Trattamento anticalcare:**  
Glass treatment:  
Traitement verre:



**Lato**  
Side  
Verre

**Vetro Extralight / Timeless:**  
Extralight/Timeless glass:  
Verre Extralight/Timeless:



**Vetro con serigrafie:**  
Serigraphies (see page 371):  
Sérigraphies (voir page 371):



**maggiorazione dal TRASPARENTE**  
increase on the TRASPARENTE price  
à partir du prix du TRASPARENTE

**Vetro Nuvola:**  
Nuvola glass (see page 371):  
Verre Nuvola (voir page 371):



**Profili speciali:**  
Special profiles:  
Profils special:

> LACCATO  
> LACQUERED  
> LAQUE



**Porta**  
Door  
Porte

**Fisso**  
Fixed panel  
Côté fixe

# BEST BATTENTE

Angolo  
Corner  
Coin

Porta battente + fisso laterale  
Hinged door + fixed lateral panel  
Porte battante + côté fixe latéral

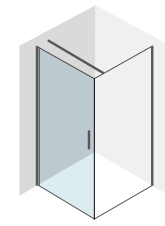

**ATTENZIONE**  
Specificare il verso al momento dell'ordine.  
**ATTENTION**  
Indicate the side in the order.  
**ATTENTION**  
Indiquer le vers dans la commande.

## P - PORTA BATTENTE / HINGED DOOR / PORTE BATTANTE

ART. ITEM ART.	ESTENSIBILITÀ EXTENSIBILITY EXTENSIBILITÉ	PIATTO TRAY RECEVEUR	APERTURA OPENING ENTRÉE	FISSO FIXED FIXE	PROFILO PROFILE PROFIL	VETRO/GLASS/VERRE TRASPARENTE	VETRO/GLASS/VERRE GRIGIO EUROPA SATIN - BRONZO
D6LA200	67,5-69,5	70	59		BRILL		
					NERO		
D6LA205	72,5-74,5	75	64		BRILL		
					NERO		
D6LA210	77,5-79,5	80	69		BRILL		
					NERO		
D6LA215	82,5-84,5	85	74		BRILL		
					NERO		
D6LA220	87,5-89,5	90	79		BRILL		
					NERO		
D6LA225	92,5-94,5	95	84		BRILL		
					NERO		
D6LA230	97,5-99,5	100	89		BRILL		
					NERO		

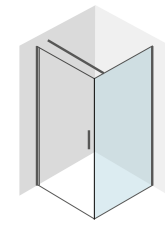

**ATTENZIONE**  
Specificare il verso al momento dell'ordine.  
**ATTENTION**  
Indicate the side in the order.  
**ATTENTION**  
Indiquer le vers dans la commande.

## L - FISSO / FIXED LATERAL PANEL / CÔTÉ FIXE LATÉRAL

ART. ITEM ART.	ESTENSIBILITÀ EXTENSIBILITY EXTENSIBILITÉ	PIATTO TRAY RECEVEUR			PROFILO PROFILE PROFIL	VETRO/GLASS/VERRE TRASPARENTE	VETRO/GLASS/VERRE GRIGIO EUROPA SATIN - BRONZO
D6LA500	67,5-69,5	70			BRILL		
					NERO		
D6LA505	72,5-74,5	75			BRILL		
					NERO		
D6LA510	77,5-79,5	80			BRILL		
					NERO		
D6LA515	82,5-84,5	85			BRILL		
					NERO		
D6LA520	87,5-89,5	90			BRILL		
					NERO		
D6LA525	92,5-94,5	95			BRILL		
					NERO		
D6LA530	97,5-99,5	100			BRILL		
					NERO		

# BEST BATTENTE

Angolo  
Corner  
Coin

Porta battente con fisso in linea + fisso laterale  
Hinged door with in-line fixed panel + fixed lat. panel  
Porte battante avec paroi fixe alignée + côté fixe latéral

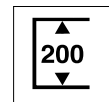

**Altezza 200 cm**  
Height 200 cm  
Hauteur 200 cm

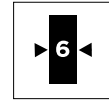

**Vetro sp. 6 mm**  
Glass th. 6 mm  
Verre ép. 6 mm



**Fuori misura:**  
**altezza max 210 cm / larghezza max 160 cm / profondità max 100 cm**  
Out of standard:  
height max. 210 cm / width max. 160 cm / depth max. 100 cm  
Sur demande:  
hauteur max. 210 cm / largeur max. 160 cm / profondeur max. 100 cm



**Braccetto (A) accorciabile in opera compreso nel prezzo**  
Stabilizing bar (A) to be cutted during installation included  
Barre de soutien (A) à couper en cours de réalisation comprise dans le prix

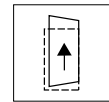

**Cerniera con sollevamento in apertura**  
Hinge with lifting mechanism while opening  
Charnière avec mécanisme de levage pendant l'ouverture



**Configurazioni:**  
Configurations:  
Configurations:

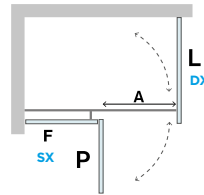

**VERSIONE SX**  
Left  
Gauche

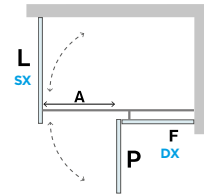

**VERSIONE DX**  
Right  
Droite

**ATTENZIONE!**

La larghezza della porta (P) è data dall'apertura (A) + 3 cm.  
Total width of the door (P) is given by width of opening (A) + 3 cm.  
La largeur totale de la porte (P) est donnée par l'addition de l'ouverture (A) + 3 cm

**Fuori Misura:**  
Out of standard:  
Sur mesure:



**(richiedere fattibilità)**  
(ask for feasibility)  
(vérifier la faisabilité avec le service technique)

**Trattamento anticalcare:**  
Glass treatment:  
Traitement verre:



**Lato**  
Side  
Verre

**Vetro Extralight / Timeless:**  
Extralight/Timeless glass:  
Verre Extralight/Timeless:



**Vetro con serigrafie:**  
Serigraphies (see page 371):  
Sérigraphies (voir page 371):



**maggiorazione dal TRASPARENTE**  
increase on the TRASPARENTE price  
à partir du prix du TRASPARENTE

**Vetro Nuvola:**  
Nuvola glass (see page 371):  
Verre Nuvola (voir page 371):



**Profili speciali:**  
Special profiles:  
Profils special:

> LACCATO  
> LACQUERED  
> LAQUE

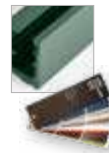

**Porta**  
Door  
Porte

**Fisso**  
Fixed panel  
Côté fixe

# BEST BATTENTE

Angolo  
Corner  
Coin

Porta battente con fisso in linea + fisso laterale  
Hinged door with in-line fixed panel + fixed lat. panel  
Porte battante avec paroi fixe alignée + côté fixe latéral

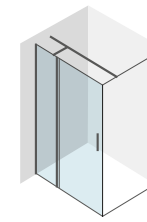

**ATTENZIONE**  
Specificare il verso al momento dell'ordine.

**ATTENTION**  
Indicate the side in the order.

**ATTENTION**  
Indiquer le vers dans la commande.

## P - PORTA BATTENTE / HINGED DOOR / PORTE BATTANTE

ART. ITEM ART.	ESTENSIBILITÀ EXTENSIBILITY EXTENSIBILITÉ	PIATTO TRAY RECEVEUR	APERTURA OPENING ENTRÉE	FISSO FIXED FIXE	PROFILO PROFILE PROFIL	VETRO/GLASS/VERRE TRASPARENTE	VETRO/GLASS/VERRE GRIGIO EUROPA SATIN - BRONZO
D6LA300	77,5-79,5	80	49	25	BRILL NERO		
D6LA305	82,5-84,5	85	49	30	BRILL NERO		
D6LA310	87,5-89,5	90	59	25	BRILL NERO		
D6LA315	92,5-94,5	95	59	30	BRILL NERO		
D6LA320	97,5-99,5	100	59	35	BRILL NERO		
D6LA325	102,5-104,5	105	64	35	BRILL NERO		
D6LA330	107,5-109,5	110	64	40	BRILL NERO		
D6LA335	112,5-114,5	115	64	45	BRILL NERO		
D6LA340	117,5-119,5	120	64	50	BRILL NERO		
D6LA345	122,5-124,5	125	64	55	BRILL NERO		
D6LA350	127,5-129,5	130	64	60	BRILL NERO		
D6LA355	132,5-134,5	135	64	65	BRILL NERO		
D6LA360	137,5-139,5	140	64	70	BRILL NERO		
D6LA365	142,5-144,5	145	64	75	BRILL NERO		
D6LA370	147,5-149,5	150	64	80	BRILL NERO		
D6LA375	152,5-154,5	155	69	80	BRILL NERO		
D6LA380	157,5-159,5	160	69	85	BRILL NERO		

## L - FISSO / FIXED LATERAL PANEL / CÔTÉ FIXE LATÉRAL

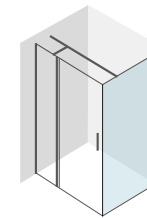

**ATTENZIONE**  
Specificare il verso al momento dell'ordine.

**ATTENTION**  
Indicate the side in the order.

**ATTENTION**  
Indiquer le vers dans la commande.

ART. ITEM ART.	ESTENSIBILITÀ EXTENSIBILITY EXTENSIBILITÉ	PIATTO TRAY RECEVEUR			PROFILO PROFILE PROFIL	VETRO/GLASS/VERRE TRASPARENTE	VETRO/GLASS/VERRE GRIGIO EUROPA SATIN - BRONZO
D6LA500	67,5-69,5	70			BRILL NERO		
D6LA505	72,5-74,5	75			BRILL NERO		
D6LA510	77,5-79,5	80			BRILL NERO		
D6LA515	82,5-84,5	85			BRILL NERO		
D6LA520	87,5-89,5	90			BRILL NERO		
D6LA525	92,5-94,5	95			BRILL NERO		
D6LA530	97,5-99,5	100			BRILL NERO		

# BEST BATTENTE

Angolo  
Corner  
Coin

2 porte battenti  
2 hinged doors  
2 portes battantes

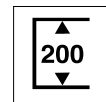

**Altezza 200 cm**  
Height 200 cm  
Hauteur 200 cm

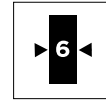

**Vetro sp. 6 mm**  
Glass th. 6 mm  
Verre ép. 6 mm



**Fuori misura:**  
**altezza max 210 cm / larghezza max 100 cm**  
Out of standard:  
height max. 210 cm / width max. 100 cm  
Sur demande:  
hauteur max. 210 cm / largeur max. 100 cm

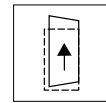

**Cerniera con sollevamento in apertura**  
Hinge with lifting mechanism while opening  
Charnière avec mécanisme de levage pendant l'ouverture

**Configurazioni:**  
Configurations:  
Configurations:

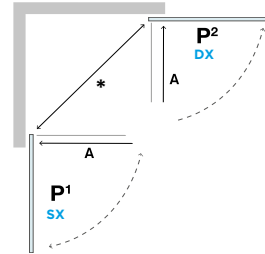

**ATTENZIONE!**

La larghezza della porta (P) è data dall'apertura (A) + 3 cm.  
Total width of the door (P) is given by width of opening (A) + 3 cm.  
La largeur totale de la porte (P) est donnée par l'addition de l'ouverture (A) + 3 cm.

**Fuori Misura:**  
Out of standard:  
Sur mesure:



**(richiedere fattibilità)**  
(ask for feasibility)  
(vérifier la faisabilité avec le service technique)

**Trattamento anticalcare:**  
Glass treatment:  
Traitement verre:



**Lato**  
Side  
Verre

**Vetro Extralight / Timeless:**  
Extralight/Timeless glass:  
Verre Extralight/Timeless:



**Vetro con serigrafie:**  
Serigraphies (see page 371):  
Sérigraphies (voir page 371):



**maggiorazione dal TRASPARENTE**  
increase on the TRASPARENTE price  
à partir du prix du TRASPARENTE

**Vetro Nuvola:**  
Nuvola glass (see page 371):  
Verre Nuvola (voir page 371):



**Profili speciali:**  
Special profiles:  
Profils special:

> LACCATO  
> LACQUERED  
> LAQUE



**Porta**  
Door  
Porte

# BEST BATTENTE

Angolo  
Corner  
Coin

2 porte battenti  
2 hinged doors  
2 portes battantes

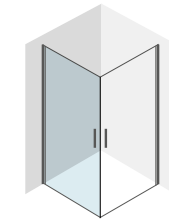

**ATTENZIONE**  
Specificare il verso al momento dell'ordine.  
**ATTENTION**  
Indicate the side in the order.  
**ATTENTION**  
Indiquer le vers dans la commande.

## P - PORTA BATTENTE / HINGED DOOR / PORTE BATTANTE

ART. ITEM ART.	ESTENSIBILITÀ EXTENSIBILITÉ	PIATTO TRAY RECEVEUR	APERTURA OPENING ENTRÉE	FISSO FIXED FIXE	PROFILO PROFILE PROFIL	VETRO/GLASS/VERRE TRASPARENTE	VETRO/GLASS/VERRE GRIGIO EUROPA SATIN - BRONZO
D6LA100	67,5-69,5	70	58		BRILL		
					NERO		
D6LA105	72,5-74,5	75	63		BRILL		
					NERO		
D6LA110	77,5-79,5	80	68		BRILL		
					NERO		
D6LA115	82,5-84,5	85	73		BRILL		
					NERO		
D6LA120	87,5-89,5	90	78		BRILL		
					NERO		
D6LA125	92,5-94,5	95	83		BRILL		
					NERO		
D6LA130	97,5-99,5	100	88		BRILL		
					NERO		

**ATTENZIONE!**

Per il calcolo del prezzo totale vanno sommati 2 lati.

**ATTENTION!**

The total price is given by the addition of 2 sides.

**ATTENTION!**

Le prix total est donné par l'addition des 2 côtés.

**DIMENSIONI APERTURA (\*):**  
ENTRANCE DIMENSIONS (\*):  
DIMENSIONS DE PASSAGE (\*):

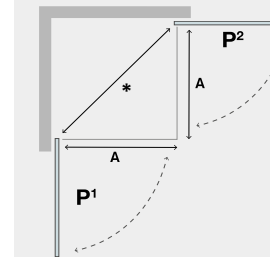

	70	75	80	85	90	95	100			
70	82	86	89	93	97	101	105			
75	86	89	93	96	100	104	108			
80	89	93	96	100	103	107	111			
85	93	96	100	103	107	111	114			
90	97	100	103	107	110	114	118			
95	101	104	107	111	114	117	121			
100	105	108	111	114	118	121	124			



# BEST BATTENTE

Angolo  
Corner  
Coin

2 porte battenti con fisso in linea  
2 hinged doors with in-line fixed panel  
2 portes battantes avec parois fixe alignée

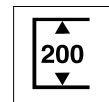

**Altezza 200 cm**  
Height 200 cm  
Hauteur 200 cm

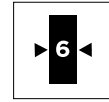

**Vetro sp. 6 mm**  
Glass th. 6 mm  
Verre ép. 6 mm



**Fuori misura:**  
**altezza max 210 cm / larghezza max 140 cm**  
Out of standard:  
height max. 210 cm / width max. 140 cm  
Sur demande:  
hauteur max. 210 cm / largeur max. 140 cm

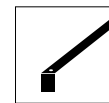

**Braccetti a 45° (inclusi nel prezzo)**  
Stabilizing bars 45° (included)  
Barres de soutien à 45° (incluses)

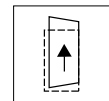

**Cerniera con sollevamento in apertura**  
Hinge with lifting mechanism while opening  
Charnière avec mécanisme de levage pendant l'ouverture

**Configurazioni:**  
Configurations:  
Configurations:

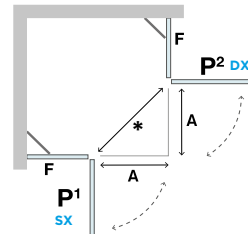

**ATTENZIONE!**

La larghezza della porta (P) è data dall'apertura (A) + 3 cm.  
Total width of the door (P) is given by width of opening (A) + 3 cm.  
La largeur totale de la porte (P) est donnée par l'addition de l'ouverture (A) + 3 cm

**Fuori Misura:**  
Out of standard:  
Sur mesure:



**(richiedere fattibilità)**  
(ask for feasibility)  
(vérifier la faisabilité avec le service technique)

**Trattamento anticalcare:**  
Glass treatment:  
Traitement verre:



**Lato**  
Side  
Verre

**Vetro Extralight / Timeless:**  
Extralight/Timeless glass:  
Verre Extralight/Timeless:



**Vetro con serigrafie:**  
Serigraphies (see page 371):  
Sérigraphies (voir page 371):



**maggiorazione dal TRASPARENTE**  
increase on the TRASPARENTE price  
à partir du prix du TRASPARENTE

**Vetro Nuvola:**  
Nuvola glass (see page 371):  
Verre Nuvola (voir page 371):



**Profili speciali:**  
Special profiles:  
Profils special:



**Porta**  
Door  
Porte

> LACCATO  
> LACQUERED  
> LAQUE

# BEST BATTENTE

Angolo  
Corner  
Coin

2 porte battenti con fisso in linea  
2 hinged doors with in-line fixed panel  
2 portes battantes avec parois fixe alignée

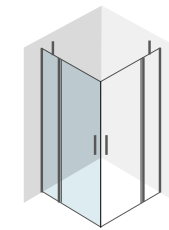

**ATTENZIONE**  
Specificare il verso al momento dell'ordine.

**ATTENTION**  
Indicate the side in the order.

**ATTENTION**  
Indiquer le vers dans la commande.

## P - PORTA BATTENTE / HINGED DOOR / PORTE BATTANTE

ART. ITEM ART.	ESTENSIBILITÀ EXTENSIBILITY EXTENSIBILITÉ	PIATTO TRAY RECEVEUR	APERTURA OPENING ENTRÉE	FISSO FIXED FIXE	PROFILO PROFILE PROFIL	VETRO/GLASS/VERRE TRASPARENTE	VETRO/GLASS/VERRE GRIGIO EUROPA SATIN - BRONZO
D6LA400	77,5-79,5	80	48	17	BRILL NERO		
D6LA405	82,5-84,5	85	48	22	BRILL NERO		
D6LA410	87,5-89,5	90	58	17	BRILL NERO		
D6LA415	92,5-94,5	95	58	22	BRILL NERO		
D6LA420	97,5-99,5	100	58	27	BRILL NERO		
D6LA425	102,5-104,5	105	63	27	BRILL NERO		
D6LA430	107,5-109,5	110	63	32	BRILL NERO		
D6LA435	112,5-114,5	115	63	37	BRILL NERO		
D6LA440	117,5-119,5	120	63	42	BRILL NERO		
D6LA445	122,5-124,5	125	68	42	BRILL NERO		
D6LA450	127,5-129,5	130	68	47	BRILL NERO		
D6LA455	132,5-134,5	135	68	52	BRILL NERO		
D6LA460	137,5-139,5	140	68	57	BRILL NERO		

**ATTENZIONE!**

Per il calcolo del prezzo totale vanno sommati 2 lati.

**ATTENTION!**

The total price is given by the addition of 2 sides.

**ATTENTION!**

Le prix total est donné par l'addition des 2 côtés.

**DIMENSIONI**

**APERTURA (\*):**  
ENTRANCE DIMENSIONS (\*):  
DIMENSIONS DE PASSAGE (\*):

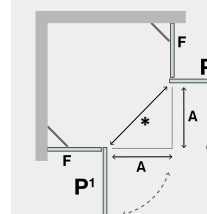

	80	85	90	95	100	105	110	115	120	125	130	135	140
80		68		75		79		83					
85													
90													
95		75		82		86		89					
100													

DISEGNO DRAWING DESSIN	DESCRIZIONE DESCRIPTION DESCRIPTION	FINITURA FINISH FINITION	ART. ITEM ART.
	BRACCETTO <b>MURO-VETRO</b> L 119 CM STABILIZING BAR <b>WALL-PANEL</b> W. 119 CM BARRE DE STABILIZATION <b>MUR-PAROI</b> L 119 CM	BRILL	D8XR005B
		NERO	D8XR005N
		SPECIAL	D8XR005*
	BRACCETTO <b>MURO-VETRO</b> L 159 CM STABILIZING BAR <b>WALL-PANEL</b> W. 159 CM BARRE DE STABILIZATION <b>MUR-PAROI</b> L 159 CM	BRILL	D8XR011B
		NERO	D8XR011N
		SPECIAL	D8XR011*
	BRACCETTO <b>MURO-MURO</b> L 199 CM STABILIZING BAR <b>WALL-WALL</b> W. 199 CM BARRE DE STABILIZATION <b>MUR-MUR</b> L 199 CM	BRILL	D8XR010B
		NERO	D8XR010N
		SPECIAL	D8XR010*
	BRACCETTO <b>CORTO</b> L 100 CM STABILIZING BAR <b>REDUCED DIMENSION</b> W. 100 CM BARRE DE STABILIZATION <b>DIMENSION RÉDUITES</b> L 100 CM	BRILL	D8XR007B
		NERO	D8XR007N
		SPECIAL	D8XR007*
	BRACCETTO <b>45°</b> L 33 CM STABILIZING BAR FOR <b>45°</b> APPLICATION (W. 33 CM) BARRE DE STABILIZATION POUR APPLICATION À <b>45°</b> (L 33 CM)	BRILL	D8XR004B
		NERO	D8XR004N
		SPECIAL	D8XR004*
	BRACCETTO <b>45°</b> L 43 CM STABILIZING BAR FOR <b>45°</b> APPLICATION (W. 43 CM) BARRE DE STABILIZATION POUR APPLICATION À <b>45°</b> (L 43 CM)	BRILL	D8XR009B
		NERO	D8XR009N
		SPECIAL	D8XR009*

DISEGNO DRAWING DESSIN	DESCRIZIONE DESCRIPTION DESCRIPTION	FINITURA FINISH FINITION	ART. ITEM ART.
	PROFILO ALLUNGAMENTO ANGOLO <b>30 x 20 x 2000</b> SHIM PROFILE IN CORNER <b>30 x 20 x 2000</b> PROFILLE DE COMPENSATION EN COIN <b>30 x 20 x 2000</b>	BRILL	DPAU003B
		NERO	DPAU003N
		SPECIAL	DPAU003*
	PROFILO ALLUNGAMENTO NICCHIA <b>40 x 20 x 2000</b> SHIM PROFILE IN NICHE <b>40 x 20 x 2000</b> PROFILLE DE COMPENSATION EN NICHE <b>40 x 20 x 2000</b>	BRILL	DPAU002B
		NERO	DPAU002N
		SPECIAL	DPAU002*
	PROFILO FISSAGGIO LATERALE <b>40 x 30 x 2000</b> LATERAL FIXING PROFILE <b>40 x 30 x 2000</b> PROFILLE POUR FIXATION LATÉRALE <b>40 x 30 x 2000</b>	BRILL	DPAU001B
		NERO	DPAU001N
		SPECIAL	DPAU001*
	GUARNIZIONE <b>VERTICALE</b> <b>SNODO</b> <b>VERTICAL GASKET</b> JOINT <b>VERTICAL</b> POUR PROFIL		DGMA0320
	GUARNIZIONE <b>INFERIORE</b> <b>BOTTOM GASKET</b> JOINT <b>INFÉRIEUR</b>		DGMA0030